

REV.	DESCRIPTION	DATE
A	NEW DRAWING	12/1/2008

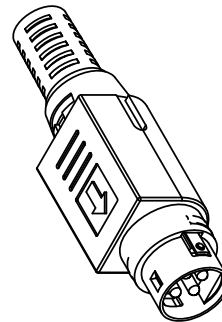

SCALE: 1:2

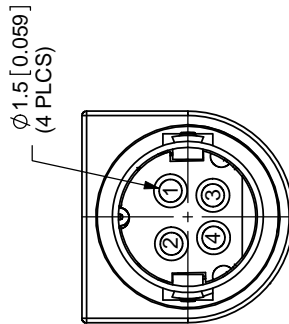
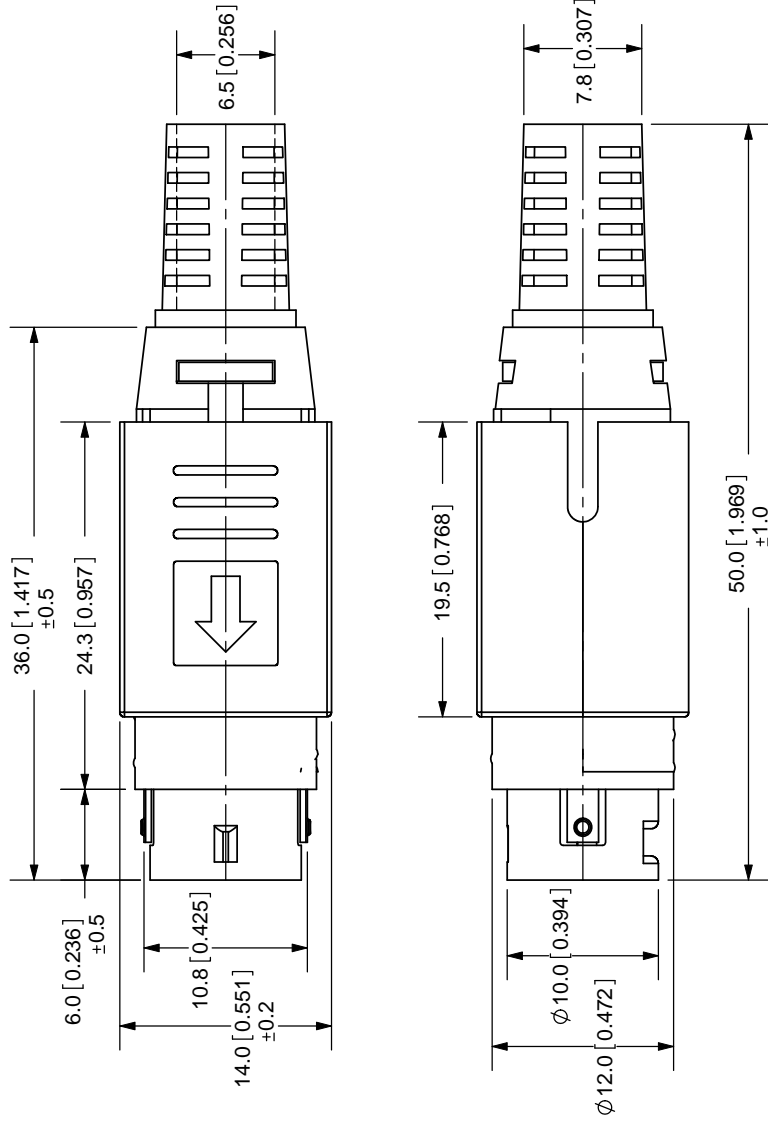

TOLERANCE:
±0.2mm UNLESS OTHERWISE
SPECIFIED

SPECIFICATIONS:
RATING: 20V DC @ 7.5A
INSULATION RESISTANCE: 50M OHMS MIN: 250V DC
VOLTAGE WITHSTAND: 250V AC R.M.S. FOR 1 MINUTE
LIFE: 5,000 CYCLES



20050 SW 112th Ave.
Tualatin, OR 97062
Phone: 503-612-2300
800-275-4899
Fax: 503-612-2383
Website: www.cui.com

MATERIAL	PLATING
OUTER HOOD	ABS
METAL SLEEVE	Brass
CLAMP	Brass
PIN/BODY	Brass/PBT
PLASTIC RING	POM
METAL COVER	Brass
SPRING	Steel
INNER HOOD	ABS
STRAIN RELIEF	PVC

TITLE: 4-PIN POWER DIN PLUG
REV: A





PART NO: PDP-40
UNITS: MM [INCHES]

DRAWN BY: ZRJ
APPROVED BY:
SCALE: 2:1

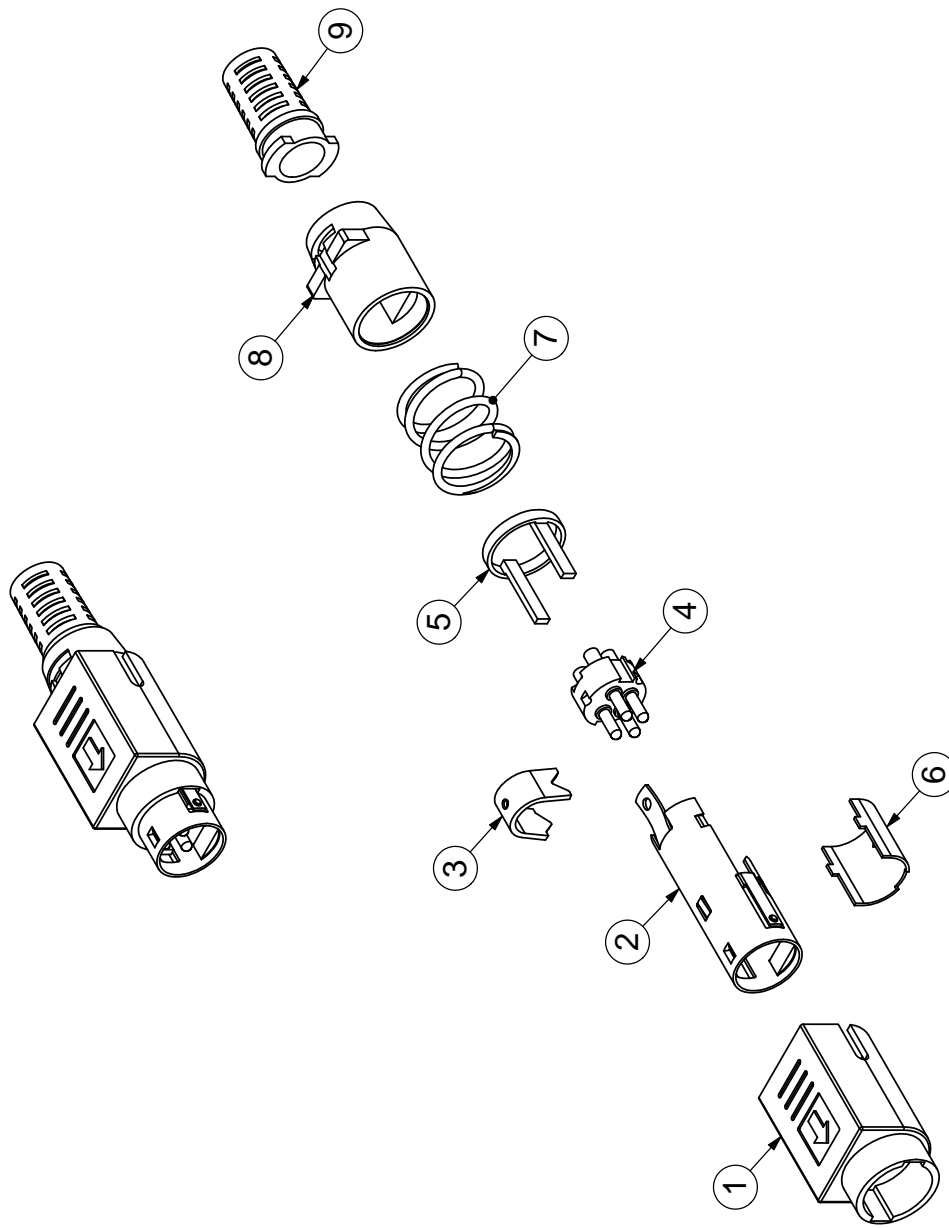
PC FILE NAME: PDP-40

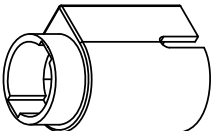
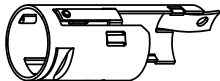
COPYRIGHT 2008 BY CUI INC.

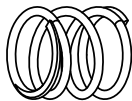

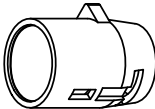
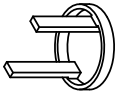
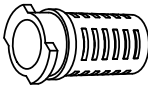
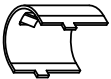
1	outer hood		
2	metal sleeve		
3	clamp		
4	pin body		
5	plastic ring		
6	strain relief		
7	spring		
8	inner hood		
9	metal cover		

TITLE: 4-PIN POWER DIN PLUG	REV: A
PART NO: PDP-40	UNITS: MM [INCHES]
DRAWN BY: ZRJ	APPROVED BY:
	SCALE: 1:1

STEP 1

insert strain relief (9), inner hood (8), and spring (7) onto cable

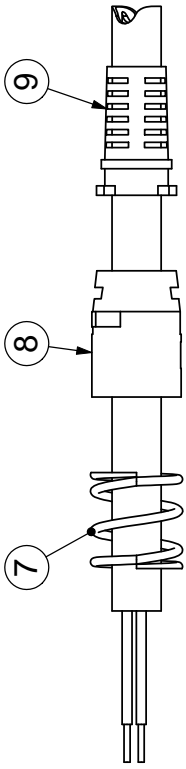

STEP 2

solder wires to contacts on pin body (4)

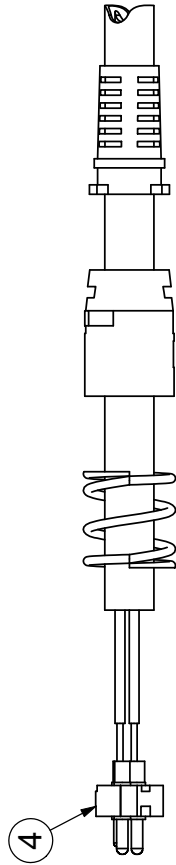

STEP 3

push pin body (4) and plastic ring (5) into metal sleeve (2)

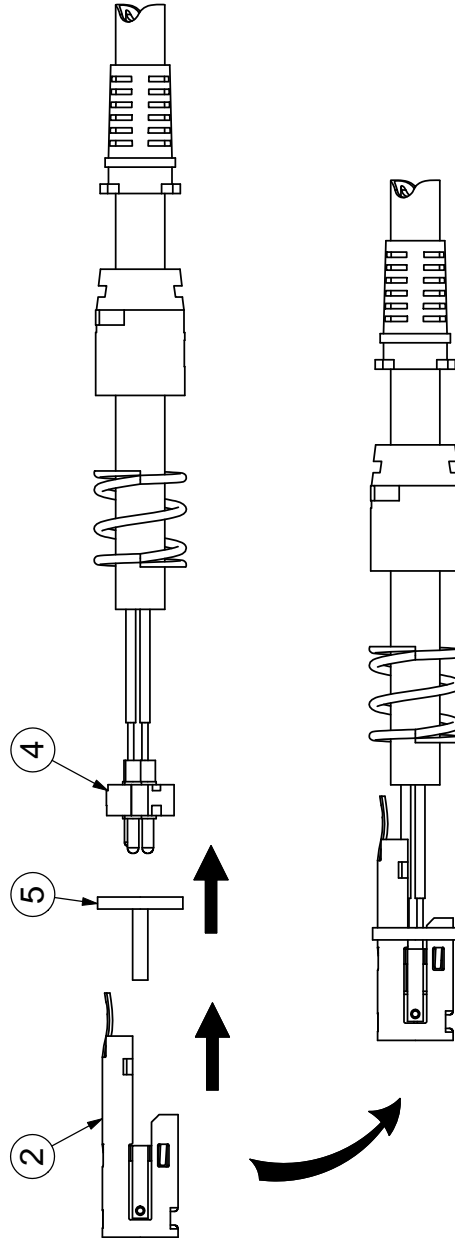

TITLE: 4-PIN POWER DIN PLUG	REV: A
PART NO: PDP-40	UNITS: MM [INCHES]
DRAWN BY: ZRJ	APPROVED BY:
	SCALE: 1:1

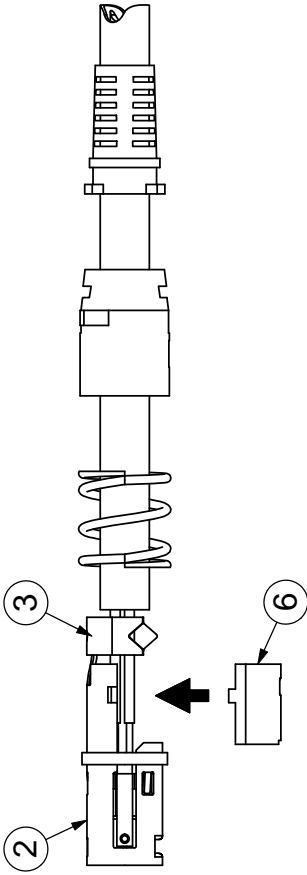

STEP 4
crimp the clamp (3)
onto wires, assemble
metal cover (6) onto
metal sleeve (2)

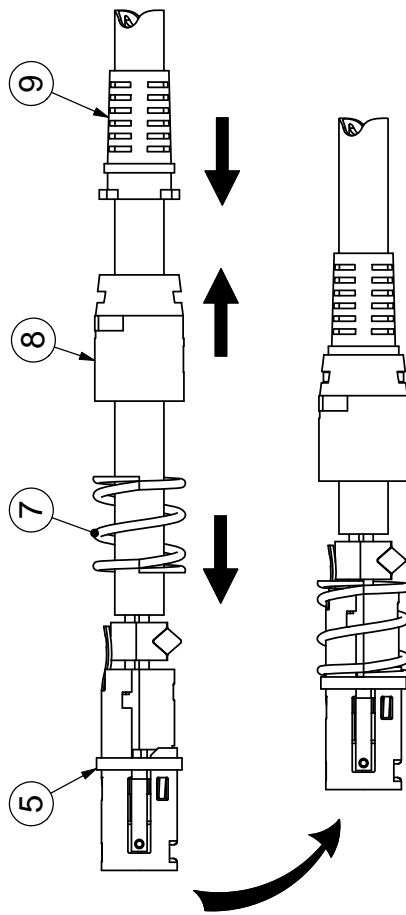

STEP 5
push spring (7) up
to plastic ring (5),
assemble inner hood (8)
and strain relief (9)
together

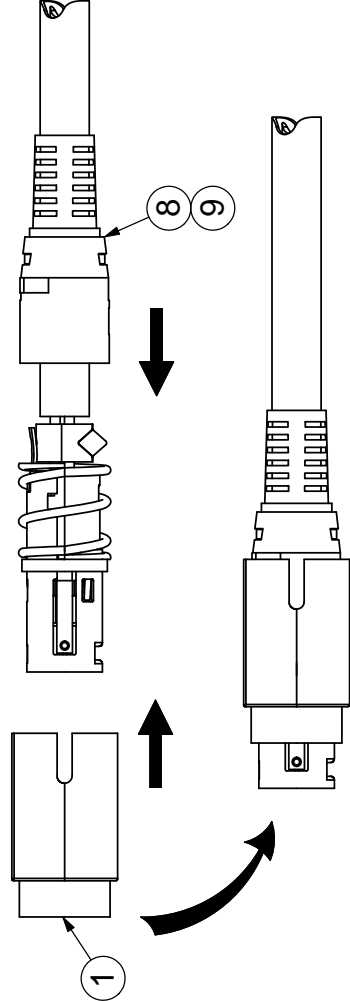

STEP 6
push outer hood (1)
and inner hood/
strain relief (8,9)
together

TITLE: 4-PIN POWER DIN PLUG	REV: A
PART NO: PDP-40	UNITS: MM [INCHES]
DRAWN BY: ZRJ	APPROVED BY:
	SCALE: 1:1